

# New Concept Connector Type Manifold

## Series SV1000/2000/3000/4000

- The use of multi-pin connectors to replace wiring inside manifold blocks provides flexibility when adding stations or changing manifold configuration.

Series SV employs a multi-connector instead of the conventional lead wires for internal. By connecting each block with a connector, changes to manifold stations are greatly simplified.

### Connector wiring diagram

For both serial and parallel wiring, additional manifold blocks are sequentially assigned pins on the connector. This makes it completely unnecessary to disassemble the connector unit.

**Service life of 50 million cycles or  
(Based on SMC life test conditions)**

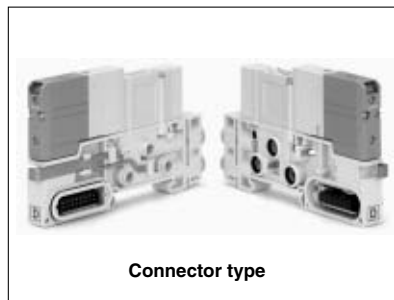
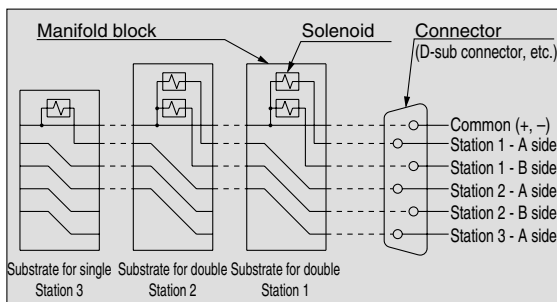

### ■ Cassette base type manifold (For SV1000/2000)

Cassette base type manifolds offer the ultimate in flexibility. Manifold sections can be added using a simple release mechanism.

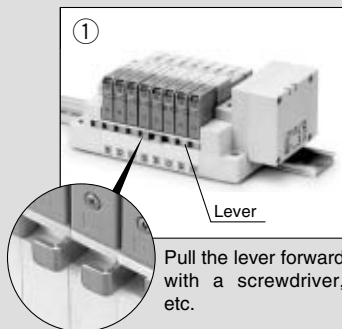

Pull the lever forward with a screwdriver, etc.

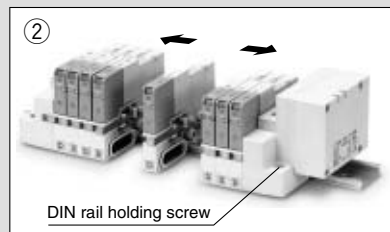

Loosen the screws that hold the DIN rail at both sides and separate the manifold to the right and left.

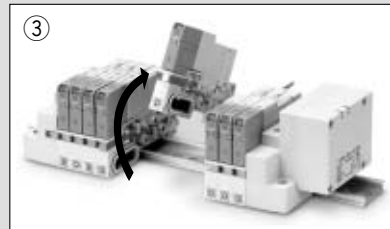

Pull the valve up at the front.



**Power  
(Current:**

### ■ Tie-rod base manifold (For SV1000/2000/3000/4000)

Conventional tie-rod base type manifolds are also available. 34 pins connector allows up to 16 stations with double solenoids.

- A relay output module of devices up to 110

■ Product is CE compliant with standard part number. 

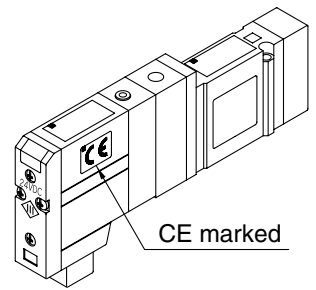

■ Serial wiring gateway type Series EX500

- IP67 protection (Gateway unit and input manifold are compliant with IP65.)
- No. of input/output point: 128 points (Output 64 points, Input 64 points)
- Controls up to 4 branches with 32 I/O per branch
- A single cable from the gateway provides both signal and power for each branch, eliminating the need for separate power connections for each manifold.

■ Serial wiring with I/O unit Series EX250

- IP67 compliant
- No. of input/output point: 64 points (Output 32 points, Input 32 points)
- Double solenoid allows up to 16 stations (up to 32 solenoids).

■ Interface regulator Series SV1000, 2000, 3000, 4000

- P port regulation, A port regulation and B port regulation are selectable, depending on an application. Able to set the pressure arbitrarily for each station of the manifold just by inserting between manifold base and valve.

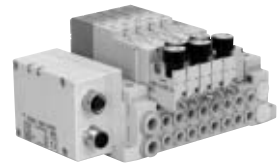

■ Increased moisture and dust resistance.

- Enclosure against foreign matters and water is conforming to IP67\*. Can be used in an atmosphere where the valve or manifold is exposed by water, etc. directly. (\* Based on IEC529) (Refer to the catalog contents for details, as some types of connectors do not meet these standards.)

■ 4 position dual 3 port valves available for Series SV1000/2000

- Two 3 port valves built into a single valve body.
- A and B ports can be individually controlled.
- Three combinations are available: [N.C./N.C.], [N.O./N.O.], and [N.C./N.O.].
- Mixed mounting with 5 port valves is also possible.
- Labels are attached to indicate A and B side functions, using the same color as the manual override.

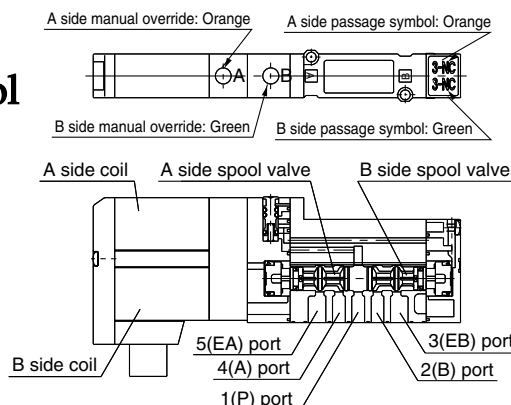

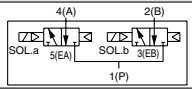
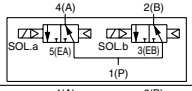
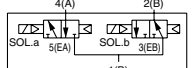
Model	A side	B side	JIS Symbol
SV <sub>2</sub> A00	N.C. valve	N.C. valve	
SV <sub>2</sub> B00	N.O. valve	N.O. valve	
SV <sub>2</sub> C00	N.C. valve	N.O. valve	

\* External pilot specifications is not available for 4 position dual 3 port valves.

SV
SZ
SY
SYJ
SX

more

consumption: 0.6 W  
25 mA, 24 VDC)

is available for control  
VAC, 3 A.



## ⚠️ Precautions 1

Be sure to read before handling. For Safety Instructions and Solenoid Valve Precautions, refer to page 1-7-2.

### Environment

#### ⚠️ Warning

- Do not use valves in atmospheres of corrosive gases, chemicals, salt water, water, steam, or where there is direct contact with any of these.
- Products compliant with IP65 and IP67 enclosures (Based on IEC529) are protected against dust and water, however, these products cannot be used in water.
- Products compliant with IP65 and IP67 enclosures satisfy the specifications by mounting each product properly. Be sure to read the Specific Product Precautions for each product.
- When using built-in silencer type manifold with an IP67 enclosure, keep the exhaust port of the silencer from coming in direct contact with water or other liquids. Liquid filtration through the exhaust port of the silencer can cause damage to the valve.

### Manual Override Operation

#### ⚠️ Warning

Handle carefully, as connected equipment can be actuated through manual override operation.

#### ■ Non-locking push type

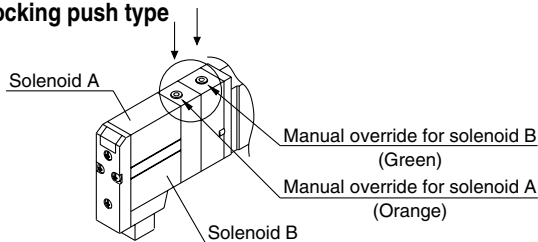

#### ■ Push-turn locking slotted type

After pushing down, turn in the direction of the arrow. If it is not turned, it can be operated the same way as the non-locking type.

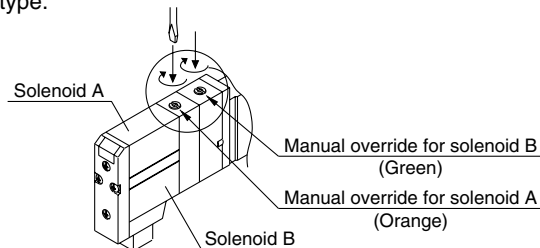

#### ⚠️ Caution

When locking the manual override with the push-turn locking slotted type, be sure to push it down before turning. Turning without first pushing it down can cause damage to the manual override and other trouble such as air leakage, etc.

### Exhaust Restriction

#### ⚠️ Caution

Since Series SV is a type in which the pilot valve exhaust joins the main valve exhaust inside the valve, use caution, so that the piping from the exhaust port is not restricted.

### Series SV Used as a 3 Port Valve

#### ⚠️ Caution

##### In the case of using a 5 port valve

Series SV can be used as normally closed (N.C.) or normally open (N.O.) 3 port valves by closing one of the cylinder ports (A or B) with a plug. However, they should be used with the exhaust ports kept open. They are convenient at times when a double solenoid type 3 port valve is required.

Plug position		B port	A port
Actuation		N.C.	N.O.
Number of solenoids	Single		
	Double		

### Light/Surge Voltage Suppressor

#### ⚠️ Caution

Solenoid valves have no polarity. Light/Surge voltage suppressor

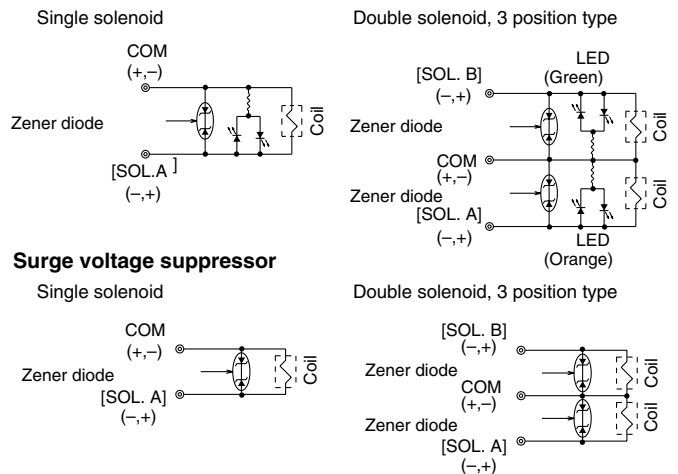

### Light Indication

#### ⚠️ Caution

When equipped with indicator light and surge voltage suppressor, the light window turns orange when solenoid A is energized, and it turns green when solenoid B is energized.

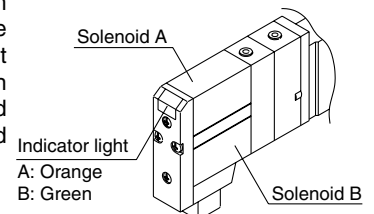

## ⚠️ Precautions 2

Be sure to read before handling. For Safety Instructions and Solenoid Valve Precautions, refer to page 1-7-2.

### Connector Entry Directions

#### ⚠️ Caution

Connector entry directions for D-sub connectors and flat ribbon cables can be changed. To change the connector's entry direction, press the levers on both sides of the connector, take it off, and change the direction as shown in the drawing. Since lead wire assemblies are attached to the connector, excessive pulling or twisting can cause broken wires or other trouble. Also, take precautions so that lead wires are not caught and pinched when installing the connector.

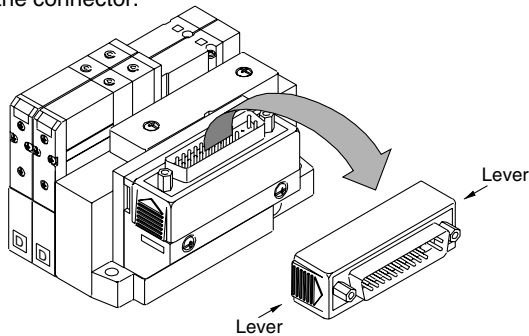

### How to Order Manifold

#### ⚠️ Caution

The letter "S" or "D" is indicated on manifold blocks for series SV as shown below. This indication refers to the type of substrate assembly (single wiring or double wiring) inside the manifold blocks.

When the manifold specification sheet does not include a wiring specification, all stations will be double wiring specification (D). In this case, single and double solenoid valves can be mounted in any position, but when a single valve is used, there will be an unused control signal. To avoid this, indicate positions of manifold blocks for single wiring specification (S) and double wiring specification (D) on a manifold specification sheet. (Note that double, 3 or 4 position valves cannot be used for manifolds blocks with single wiring specification (S).)

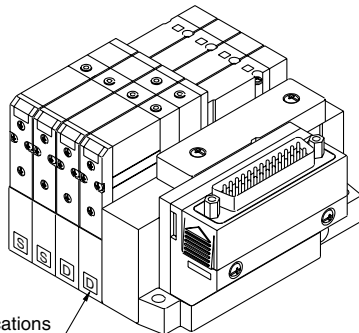

Wiring specifications symbol

### Substrate Assemblies inside Manifolds

#### ⚠️ Caution

Substrate assemblies inside of manifolds cannot be taken apart. Attempting to do so may damage parts.

### One-touch Fittings

#### ⚠️ Caution

##### 1. Tube attachment/detachment for One-touch fittings

###### 1) Attaching of tube

- (1) Take a tube having no flaws on its periphery and cut it off at a right angle. When cutting the tube, use tube cutters TK-1, 2 or 3. Do not use pinchers, nippers or scissors, etc. If cutting is done with tools other than tube cutters, there is the danger that the tube may be cut diagonally or become flattened, etc., making a secure installation impossible, and causing problems such as the tube pulling out after installation or air leakage. Also allow some extra length in the tube.
- (2) Grasp the tube and push it in slowly, inserting it securely all the way into the fitting.
- (3) After inserting the tube, pull on it lightly to confirm that it will not come out. If it is not installed securely all the way into the fitting, this can cause problems such as air leakage or the tube pulling out.

###### 2) Detaching of tube

- (1) Push in the release button sufficiently, and push the collar evenly at the same time.
- (2) Pull out the tube while holding down the release button so that it does not come out. If the release button is not pressed down sufficiently, there will be increased bite on the tube and it will become more difficult to pull it out.
- (3) When the removed tube is to be used again, cut off the portion which has been chewed before reusing it. If the chewed portion of the tube is used as is, this can cause trouble such as air leakage or difficulty in removing the tube.

### Other Tubing Brands

#### ⚠️ Caution

##### 1. When using tube other than SMC brand, confirm that the following specifications are satisfied with respect to the outside diameter tolerance of the tube.

- |                        |                                       |
|------------------------|---------------------------------------|
| 1) Nylon tubing        | within $\pm 0.1$ mm                   |
| 2) Soft nylon tubing   | within $\pm 0.1$ mm                   |
| 3) Polyurethane tubing | within $+0.15$ mm<br>within $-0.2$ mm |

Do not use tubing which does not meet these outside diameter tolerances. It may not be possible to connect them, or they may cause other trouble, such as air leakage or the tube pulling out after connection.

### Back Pressure Check Valve Built-in Type

#### ⚠️ Caution

Valves with built-in back pressure check valve is to protect the back pressure inside a valve. For this reason, use caution the valves with external pilot specification cannot be pressurized from exhaust port [3/5(E)]. As compared with the types which do not integrate the back pressure check valve, C value of the flow characteristics goes down. For details, please contact SMC.

SV

SZ

SY

SYJ

SX

## ⚠ Precautions 3

Be sure to read before handling. For Safety Instructions and Solenoid Valve Precautions, refer to page 1-7-2.

### Interface Regulator

## ⚠ Caution

### Specifications

Interface regulator	SV1□00-□-□	SV2000-□-□	SV3000-□-□	SV4000-□-□	
Applicable model	SV1000	SV2000	SV3000	SV4000	
Regulating port	P, A, B				
Set pressure range	0.1 to 0.7 MPa				
Maximum operating pressure	0.7 MPa				
Fluid	Air				
Ambient and fluid temp.	Maximum at 50°C				
Weight	With pressure gauge	38.4 g (43.4 g)	86.5 g	103.8 g	178.2 g
	Without pressure gauge	32 g (37 g)	80.3 g	97.6 g	171.8 g

Note 1) Apply pressure from P port in the base for interface regulator.

Note 2) P port pressure regulation is only available for closed center and pressure center.

Note 3) Gasket and mounting screws are included in the weight.

Note 4) ( ): Denotes the values of SV1300.

### How to Calculate the Flow Rate

For obtaining the flow rate, refer to page 1-1-12.



## ⚠ Precautions 4

Be sure to read before handling. For Safety Instructions and Solenoid Valve Precautions, refer to page 1-7-2.

### Serial Wiring EX500/EX250/EX120 Precautions

#### ⚠ Warning

1. **These products are intended for use in general factory automation equipment.**  
Avoid using these products in machinery/equipment which affects human safety, and in cases where malfunction or failure can result in extensive damage.
2. **Do not use in an explosive atmosphere, environment with inflammable gases, or corrosive atmosphere.**  
This can cause injury or fire, etc.
3. **Work such as transporting, installing, piping, wiring, operation, control and maintenance should be performed by personnel with specialized knowledge.**  
There is a danger of electrocution, injury or fire, etc.
4. **Install an external emergency stop circuit that can promptly stop operation and shut off the power supply.**
5. **Do not remodel these products, as there is a danger of injury and damage.**
6. **Do not wipe the product with chemicals, etc.**

#### ⚠ Caution

1. **Read the instruction manual carefully, strictly observe the precautions and operate within the range of the specifications.**
2. **Do not drop these products or submit them to strong impacts. This can cause damage, failure or malfunction, etc.**
3. **In locations with poor electrical conditions, take steps to ensure a steady flow of the rated power supply. Use of a voltage outside of the specifications can cause malfunction, damage to the unit, electrocution or fire, etc.**
4. **Do not touch connector terminals or internal substrates when current is being supplied. There is a danger of malfunction, damage to the unit or electrocution if connector terminals or internal substrates are touched when current is being supplied.**  
Be sure that the power supply is OFF when adding or removing manifold valves or input blocks, etc., or when connecting or disconnecting connectors.
5. **Operate at an ambient temperature that is within the specifications. Even when the ambient temperature range is within the specifications, do not use in locations where there are rapid temperature changes.**
6. **Keep wire scraps and other extraneous material from getting inside these products. This can cause fire, failure or malfunction, etc.**
7. **Give consideration to the operating environment depending on the type of enclosure being used.**  
To achieve IP65 or IP67 protection, provide appropriate wiring between all units using electrical wiring cables, communication connectors and cables with M12 connectors. Also, provide waterproof caps when there are unused ports, and perform proper mounting of input units, input blocks, SI units and manifold valves, etc. Provide a cover or other protection for applications in which there is constant exposure to water.
8. **Obey the proper tightening torque.**  
There is a possibility of damaging threads if tightening exceeds the tightening torque range.

#### ⚠ Caution

9. **Provide adequate protection when operating in locations such as the following:**
  - Where noise is generated by static electricity, etc.
  - Where there is a strong electric field
  - Where there is a danger of exposure to radiation
  - When in close proximity to power supply lines
10. **When these products are installed in equipment, provide adequate protection against noise by using noise filters, etc.**
11. **Since these products are components that are used after installation in other equipment, the customer should confirm conformity to EMC directives for the finished product.**
12. **Do not remove the name plate.**
13. **Perform periodic inspections and confirm normal operation. It may otherwise be impossible to guarantee safety due to unexpected malfunction or erroneous operation.**

### Power Supply Safety Instructions

#### ⚠ Caution

1. **Operation is possible with a single power supply or a separate power supply. However, be sure to provide two wiring systems (one for solenoid valves, and one for input and control units).**
2. **Use the following UL approved products for DC power supply combinations.**
  - 1) **Controlled voltage current circuit conforming to UL508**  
Circuit uses the secondary coil of an isolated transformer as the power supply, satisfying the following conditions.
    - Max. voltage (with no load): 30 Vrms (42.4 V peak) or less
    - Max. current: (1) 8 A or less (including shorts), and (2) When controlled by a circuit protector (fuse, etc.) with the following rating

No-load voltage (V peak)	Max. current rating
0 to 20 [V]	5.0
Over 20 [V] to 30 [V]	100
Peak voltage value	
  - 2) **A circuit (class 2 circuit) with maximum 30 Vrms (42.4 V peak) or less, and a power supply consisting of a class 2 power supply unit conforming to UL1310, or a class 2 transformer conforming to UL1585**

### Safety Instructions for Cable

#### ⚠ Caution

1. **Be careful of mis-wiring. This can cause malfunction, damage and fire in the unit.**
2. **To prevent noise and surge in signal lines, keep all wiring separate from power lines and high voltage lines. Otherwise, this can cause malfunction.**
3. **Check wiring insulation, as defective insulation can cause damage to the unit due to excessive voltage or current.**
4. **Do not bend or pull cables repeatedly, and do not place heavy objects on them or allow them to be pinched. This can cause broken lines.**

SV

SZ

SY

SYJ

SX

# INDEX

## Series SV Manifold Variations

### Serial Wiring

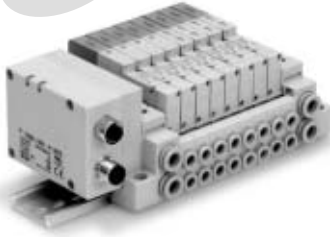

#### Valve Manifold Common Specifications

P. 1-2-14

Manifold specifications

#### Decentralized Serial Wiring

P. 1-2-17

IP67 compliant

Applicable series

Cassette base manifold  
SV1000/SV2000

Tie-rod base manifold  
SV1000/SV2000/SV3000/SV4000

- Number of output points: 16 points
- EX500 gateway communication specifications  
Remote I/O, DeviceNet, PROFIBUS-DP



#### Serial Wiring with Input/Output Unit

P. 1-2-35

IP67 compliant

Applicable series

Tie-rod base manifold  
SV1000/SV2000/SV3000

- Number of input/output points: Each 32 points



#### Dedicated Output Serial Wiring

P. 1-2-43

Applicable series

Cassette base manifold  
SV1000/SV2000

Tie-rod base manifold  
SV1000/SV2000/SV3000/SV4000

- Number of output points: 16 points

### Parallel Wiring

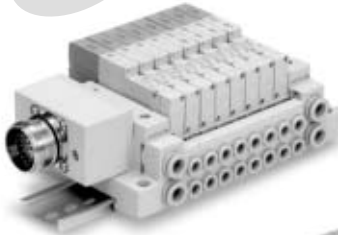

#### For Circular Connector

P. 1-2-55

IP67 compliant

Applicable series

Cassette base manifold  
SV1000/SV2000

Tie-rod base manifold  
SV1000/SV2000/SV3000/SV4000

- Number of connectors: 26 pins

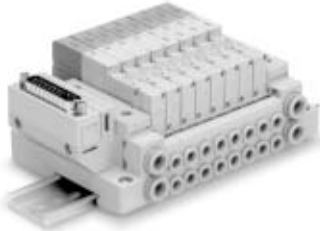

#### D-sub Connector

P. 1-2-65

Applicable series

Cassette base manifold  
SV1000/SV2000

Tie-rod base manifold  
SV1000/SV2000/SV3000/SV4000

- Number of connectors: 25 pins
- MIL-C-24308  
Conforming to JIS-X-5101

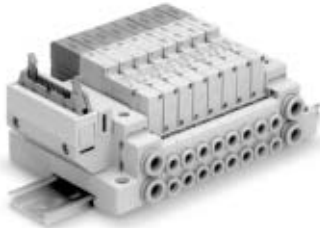

#### Flat Ribbon Cable Connector

P. 1-2-75

Applicable series

Cassette base manifold  
SV1000/SV2000

Tie-rod base manifold  
SV1000/SV2000/SV3000/SV4000

- Number of connectors: 26, 20, 10 pins
- With strain relief  
Conforming to MIL-C-83503

#### Valve Manifold Specifications

P. 1-2-86

Manifold exploded view  
Manifold option

#### Single Valve/Sub-plate [IP67 compliant]

P. 1-2-100

IP67 compliant

Applicable series

SV1000/SV2000/SV3000/SV4000

- With waterproof M12 connector



SV

SZ

SY

SYJ

SX

# Valve Manifold Common Specifications Series SV

## Cassette base manifold

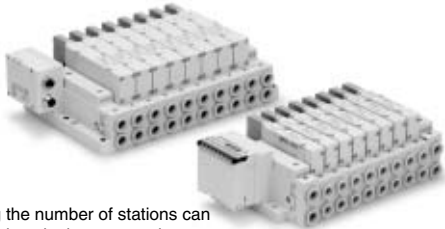

- Changing the number of stations can be easily done by lever operation.

## Manifold Specifications

Applicable series		SV1000	SV2000
Manifold type		Stacking type cassette base manifold	
1 (P: SUP)/3, 5 (E: EXH) type		Common SUP, EXH	
Valve stations (maximum)		18 stations	20 stations
Max. number of solenoids		18 points	26 points
Port size	1(P), 3/5(E) port	C8, N9	C10, N11
	4(A), 2(B) port	C3, C4, C6 N1, N3, N7	C4, C6, C8 N3, N7, N9

## Flow Characteristics

Model	Port size		Flow characteristics					
	1, 5, 3 (P, EA, EB)	4, 2 (A, B)	1 → 4/2 (P → A/B)			4/2 → 3/5 (A/B → E)		
			C [dm <sup>3</sup> /(s·bar)]	b	Cv	C [dm <sup>3</sup> /(s·bar)]	b	Cv
SS5V1-16	C8	C6	0.89	0.22	0.22	0.98	0.21	0.23
SS5V2-16	C10	C8	2.3	0.28	0.50	2.7	0.18	0.56

Note) The value is for manifold base with 5 stations and individually operated 2 position type.

## Tie-rod base manifold

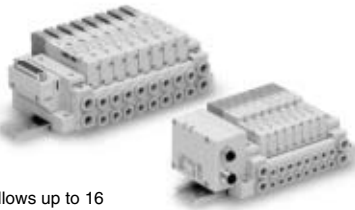

- 34 pins connector allows up to 16 stations with double solenoids.

## Manifold Specifications

Applicable series		SV1000	SV2000	SV3000	SV4000
Manifold type		Tie-rod base manifold			
1 (P: SUP)/3, 5 (E: EXH) type		Common SUP, EXH			
Valve stations (maximum)		20 stations			
Max. number of solenoids		32 points			
Port size	1(P), 3/5(E) port	C8, N9	C10, N11	C12, N11	C12, N11, 03
	4(A), 2(B) port	C3, C4, C6 N1, N3, N7	C4, C6, C8 N3, N7, N9	C6, C8, C10 N7, N9, N11	C8, C10, C12 N9, N11, 02, 03

## Flow Characteristics

Model	Port size		Flow characteristics					
	1, 5, 3 (P, EA, EB)	4, 2 (A, B)	1 → 4/2(P → A/B)			4/2 → 3/5(A/B → E)		
			C [dm <sup>3</sup> /(s·bar)]	b	Cv	C [dm <sup>3</sup> /(s·bar)]	b	Cv
SS5V1-10	C8	C6	0.98	0.26	0.24	1.1	0.35	0.28
SS5V2-10	C10	C8	2.1	0.20	0.46	2.4	0.18	0.48
SS5V3-10	C12	C10	4.2	0.22	0.91	4.3	0.21	0.93
SS5V4-10	C12	C12	6.2	0.19	1.3	7.0	0.18	1.6

Note) The value is for manifold base with 5 stations and individually operated 2 position type.

## Enclosure of Manifold Variations (Common for cassette base and tie-rod base)

Series	Enclosure (Based on IEC529)
Series EX500 Decentralized serial wiring	IP67 *
Series EX250 Serial wiring with input/output onit	IP67
Series EX120 Dedicated output serial wiring	Dusttight (IP40)
For circular connector	IP67
D-sub connector	Dusttight (IP40)
Flat ribbon cable	Dusttight (IP40)

\* Enclosure of a gateway unit and input manifold is IP65.



**Series SV Solenoid Valve Specifications**



**Made to Order Specifications**  
(For details, refer to page 1-2-108.)

**JIS Symbol**

2 position single solenoid

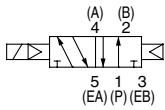

2 position double solenoid

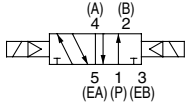

3 position closed center

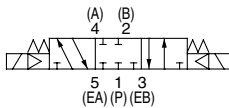

3 position exhaust center

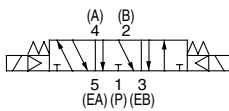

3 position pressure center

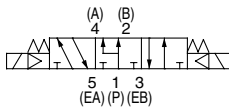

4 position dual 3 port valve: N.C./N.C.

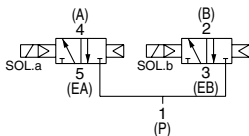

4 position dual 3 port valve: N.O./N.O.

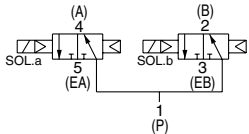

4 position dual 3 port valve: N.C./N.O.

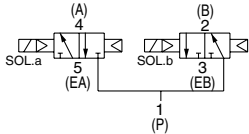

Fluid	Air	
Internal pilot Operating pressure range (MPa)	2 position single	0.15 to 0.7
	4 position dual 3 port valve	0.1 to 0.7
	3 position	0.2 to 0.7
External pilot Operating pressure range (MPa)	Operating pressure range	-100 kPa to 0.7
	2 position single, double	0.25 to 0.7
	3 position	0.25 to 0.7
Ambient and fluid temperature (°C)	-10 to 50 (No freezing. Refer to page 1-7-4.)	
Max. operating frequency (Hz)	2 position single, double	5
	4 position dual 3 port valve	3
	3 position	3
Manual override	Non-locking push type	
	Push-turn locking slotted type	
Pilot exhaust method	Internal pilot	Common exhaust type for main and pilot valve
	External pilot	Pilot valve individual exhaust
Lubrication	Not required	
Mounting orientation	Unrestricted	
Impact/Vibration resistance (ms <sup>2</sup> )	150/30	
Enclosure	IP67 (Based on IEC529)	
Coil rated voltage	24 VDC, 12 VDC	
Allowable voltage fluctuation	±10% of rated voltage	
Power consumption	0.6 (With indicator light: 0.65)	
Surge voltage suppressor	Zener diode	
Indicator light	LED	

**SV**

**SZ**

**SY**

**SYJ**

**SX**



Note) Impact resistance: No malfunction occurred when it is tested with a drop tester in the axial direction and at the right angles to the main valve and armature in both energized and de-energized states every once for each condition. (Values at the initial period)

Vibration resistance: No malfunction occurred in a one-sweep test between 45 and 2000 Hz. Test was performed at both energized and de-energized states in the axial direction and at the right angles to the main valve and armature. (Values at the initial period)

**Response Time**

Type of actuation	Response time (ms) (at the pressure of 0.5 MPa)			
	SV1000	SV2000	SV3000	SV4000
2 position single	11 or less	25 or less	28 or less	40 or less
2 position double	10 or less	17 or less	26 or less	40 or less
3 position	18 or less	29 or less	32 or less	82 or less
4 position dual 3 port valve	15 or less	33 or less	—	—



Note) Based on dynamic performance test, JIS B 8375-1981.  
(Coil temperature: 20°C, at rated voltage)

**Weight**

Series	Type of actuation	Weight (g)
SV1000	Single solenoid	66
	Double solenoid	71
	3 position	73
	4 position dual 3 port	71
SV2000	Single solenoid	74
	Double solenoid	78
	3 position	83
	4 position dual 3 port	78
SV3000	Single solenoid	99
	Double solenoid	102
	3 position	110
SV4000	Single solenoid	186
	Double solenoid	190
	3 position	211



Note) Weight of solenoid valve only.

# Decentralized Serial Wiring

## Series **EX500**

IP67 compliant

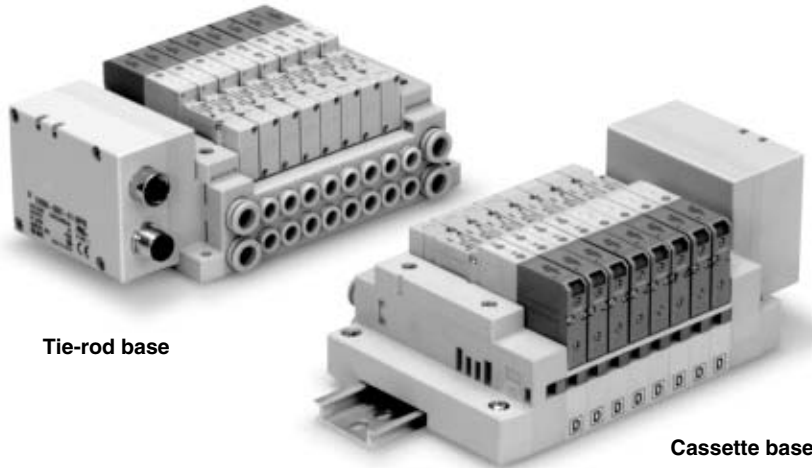

Tie-rod base

Cassette base

Applicable series	Cassette base manifold SV1000/SV2000
	Tie-rod base manifold SV1000/SV2000/SV3000/SV4000
	<ul style="list-style-type: none"><li>• Number of output points: 16 points</li><li>• EX500 gateway unit communication specifications Remote I/O, DeviceNet, PROFIBUS-DP</li></ul>

SV

SZ

SY

SYJ

SX

# Series EX500 Decentralized Serial System Configuration

A configuration of series EX500 serial system with series SV is shown below.

## Series EX500 Decentralized Serial System Configuration

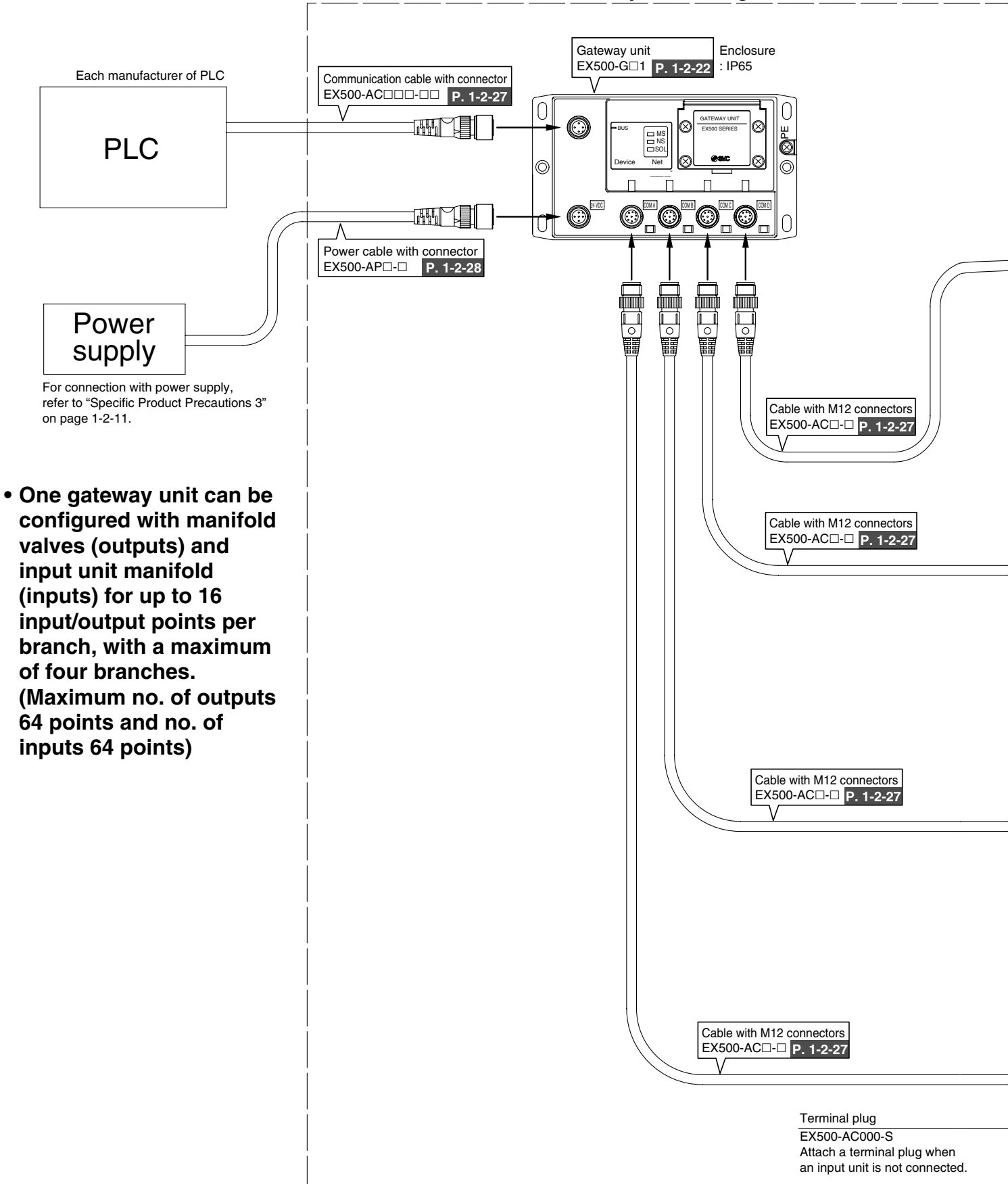

# Series EX500 Decentralized Serial Wiring Series SV

## How to Order

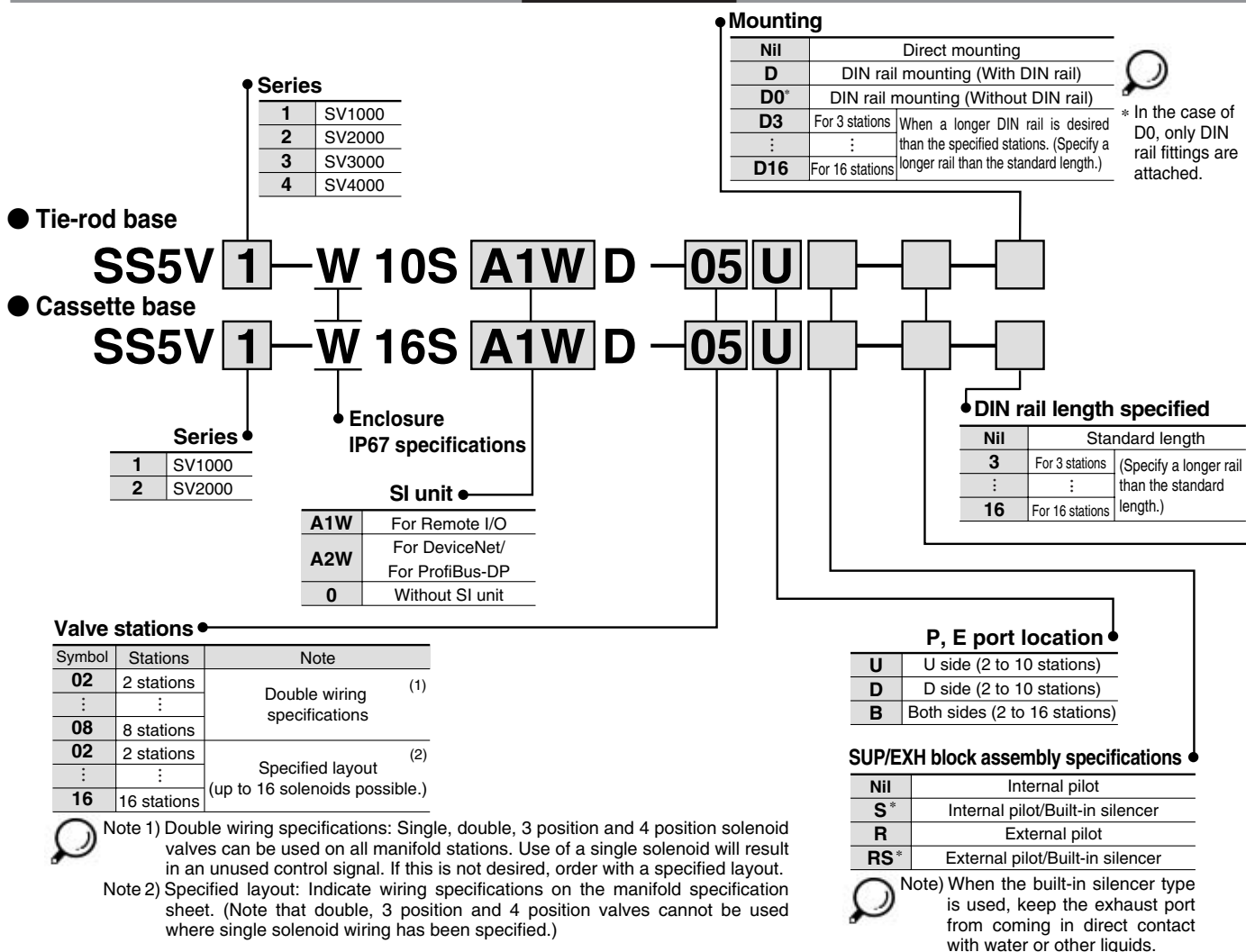

### A, B port size (metric)

Symbol	A, B port	P, E port	Applicable series
C3	One-touch fitting for ø3.2	One-touch fitting for ø8	SV1000
C4	One-touch fitting for ø4		
C6	One-touch fitting for ø6		
C4	One-touch fitting for ø4		
C6	One-touch fitting for ø6	One-touch fitting for ø10	SV2000
C8	One-touch fitting for ø8		
C6	One-touch fitting for ø6		
C8	One-touch fitting for ø8		
C10	One-touch fitting for ø10	One-touch fitting ø12	SV3000
C8	One-touch fitting for ø8		
C10	One-touch fitting for ø10		
C12	One-touch fitting for ø12		
02	Rc 1/4	Rc 3/8	SV4000
03	Rc3/8		
02F	G 1/4		
03F	G 3/8		
M	A, B ports mixed		

### A, B port size (inch)

Symbol	A, B port	P, E port	Applicable series
N1	One-touch fitting for ø1/8"	One-touch fitting for ø5/16"	SV1000
N3	One-touch fitting for ø5/32"		
N7	One-touch fitting for ø1/4"		
N3	One-touch fitting for ø5/32"	One-touch fitting for ø3/8"	SV2000
N7	One-touch fitting for ø1/4"		
N9	One-touch fitting for ø5/16"		
N7	One-touch fitting for ø1/4"	One-touch fitting for ø3/8"	SV3000
N9	One-touch fitting for ø5/16"		
N11	One-touch fitting for ø3/8"		
N9	One-touch fitting for ø5/16"	One-touch fitting for ø3/8"	SV4000
N11	One-touch fitting for ø3/8"		
02N	NPT 1/4		
03N	NPT 3/8	NPT 3/8	
02T	NPTF 1/4	NPTF 3/8	
03T	NPTF 3/8		
M	A, B ports mixed		

\* In the case of mixed specifications (M), indicate separately on the manifold specification sheet.  
\* Port sizes of X, PE port for external pilot specifications (R, RS) are ø4 (metric), ø5/32" (inch) for SV1000/2000 and ø6 (metric) and ø1/4" (inch) for SV3000/4000.